



Kiwa Nederland B.V.

Sir Winston Churchilllaan 273
NL-2288 EA Rijswijk
Postbus 70
NL-2280 AB Rijswijk
Tel.: +31 (0)88 998 44 00
Fax: +31 (0)88 998 44 20
E-mail: info@kiwa.nl



European Technical Assessment	ETA 15/0634 05/09/2021
--------------------------------------	----------------------------------

General Part

Technical Assessment Body issuing the ETA: Kiwa Nederland B.V.	
Trade name of the construction product	MAGOXX® Board
Product family to which the construction product belongs	Product area code: 35 Fire stopping, fire sealing and fire protective products
Manufacturer	SINH Building Solutions B.V. Saturnusstraat 60 unit 68 2516 AH Den Haag
Manufacturing plant(s)	Plant 1
This European Technical Assessment contains	27 pages including 6 Annexes which form an integral part of this assessment
	Annex 6 contains confidential information and is not included in the European Technical Assessment when that assessment is publicly disseminated
This European Technical Assessment is issued in accordance with regulation (EU) No 305/2011, on the basis of	EAD 350142-00-1106, edition September 2017
This European Technical Assessment replaces	ETA 15/0634 issued on 20.09.2019

Translations of this European Technical Assessment in other languages shall fully correspond to the original issued document and should be identified as such.

Communication of this European Technical Assessment, including transmission by electronic means, shall be in full (excepted the confidential Annex(es) referred to above). However, partial reproduction may be made, with the written consent of the issuing Technical Assessment Body. Any partial reproduction has to be identified as such.

Specific parts

1. Technical description of the product

1.1. General

MAGOXX® Board is a rigid, non textured mineral (MgO) bound matrix fire protective board without adhesive finishings. MAGOXX® Board can be used as an interior or exterior layer of a construction. This ETA concerns MAGOXX® Board only.

1.2. Technical characterisation

Standard ^[1] nominal dimensions of large size MAGOXX® Board:

Width * Length : 900 * 2400 mm / 2700 mm / 3000 mm
1200 * 2400 mm / 2700 mm / 3000 mm

^[1] Other dimensions up to a maximum of 1220 * 3050 mm are available on request.

Thickness : 4, 6, 9, 12, 15 and 18 mm.

Tolerances on nominal dimensions:

Nominal dimension, a ^[2]	Level I
a ≤ 600 mm	± 3 mm
600 mm < a ≤ 1000 mm	± 3 mm
1000 mm < a ≤ 1600 mm	± 0,3 % a
1600 mm ≤ a	± 5 mm

^[2] a = nominal length or width

Tolerances on thickness:

Thickness, e ^[3]	Value
e ≤ 6 mm	± 0,6 mm
6 mm < e ≤ 20 mm	± 10% e

^[3] e = nominal thickness

Tolerances on shape:

Characteristic	Level II
Straightness of edges	0,3 %
Squareness of edges	4 mm/m

Other characteristics:

Characteristic	Unit	Mean values per thickness (mm)					
		4	6	9	12	15	18
Modulus of elasticity	MPa	7682	5135	6594	7296	2442	4228
Modulus of elasticity, conditioned ^[4]	MPa	4910	3720	5564	5926	NPA	3257
Tensile strength, $\bar{\sigma}$	MPa	1,96	1,30	1,62	1,14	0,94	1,34
Tensile strength, //	N/mm ²	7,48	4,81	2,61	NPA	NPA	2,95
Compressive strength, f_c	N/mm ²	13,43	11,50	10,58	20,2	10	14,36
Apparent density	Kg/m ³	NPA	808	834	874	884	NPA

^[4] After conditioning in accordance to category A, EN 12467

2. Specification of the intended use(s) in accordance with the applicable European Assessment Document (hereinafter EAD)

2.1. Intended use

2.1.1. General

MAGOXX® Board is suitable for indoor and outdoor constructions where it is intended to be added as fire protective board for fire compartmentalisation or to building services to enhance and/or preserve their resistance to fire performance.

2.1.2. Product families related to the element(s) intended to be protected

Fire protective products are divided into 9 product families related to the elements they are intended to protect. Table 2 shows for which use types MAGOXX® Board is suitable.

Table 2: Suitable use types related to the elements to be protected

Use type	Protection of	Suitability
Type 1	Horizontal membrane protection	Yes
Type 2	Vertical membrane protection	Yes
Type 3	Load-bearing concrete elements	No
Type 4	Load-bearing steel elements	No
Type 5	load-bearing flat concrete profiled sheet composite elements	No
Type 6	Fire protective products to protect load-bearing concrete filled hollow steel columns	No
Type 7	Load-bearing timber elements	No
Type 8	Fire separating assemblies with no load-bearing requirements	Yes
Type 9	Fire protective Products that contribute to the fire resistance of technical services assemblies in buildings	No
Type 10	Uses not covered by 1-9	No

2.2. General assumptions

MAGOXX® Board is manufactured in accordance with the provisions of the European Technical Assessment using the manufacturing process as identified during the inspection of the manufacturing plant by Kiwa Nederland B.V. and laid down in the technical file. It is the responsibility of the manufacturer to ensure that all necessary information on design and installation is submitted to those responsible for design and execution of the construction.

2.3. Intended working life

The provisions made in this ETA are based on an assumed working life of 25 years, provided that:

- More than accidental wetting and/or frost is not to be expected with use of MAGOXX® Board < 9 mm.
- The indoor works are properly designed and built. The maximum acceptable deflection of the supporting constructions of non-loadbearing wall partitions shall be 10 mm.
- Installation of the MAGOXX® Board is performed as per installation guide, under normal site conditions, by adequately trained installers.
- Minor damages are repaired (for example damage caused by impact).
Minor damages can be repaired with magnesium oxide paste with traditional plastering techniques. If the fracture damage of the MAGOXX® Board is significant, this board should be replaced.
- MAGOXX® Board and the indoor works are properly used and maintained.

- The buildings where the indoor constructions are used shall have a mean air temperature in the range from 5 °C to 35 °C and a mean daily air relative humidity (RH) in the range of 20 %RH to 75 %RH. Maximum air relative humidity may only exceed 85 %RH for short periods of time.

The indications given on the working life cannot be interpreted as a guarantee given by the producer, but are to be regarded as a means for choosing the right product in relation to the reasonable expected working life of the works.

2.4. Packaging, transport and storage

MAGOXX® Board shall be packed, transported and stored in accordance to the manufacturer's technical documentation to prevent damages or deterioration. It is the responsibility of the manufacturer that adequate information is clearly shown on the package and/or enclosed instruction sheet.

2.5. Execution of the works

For MAGOXX® Board the following shall be observed:

- Mounting and handling shall be carried out by qualified employees and according to the manufacturers mounting instructions;
- The construction shall be assembled as described in this ETA;
- The construction shall only be used in conditions as stated in clause 2.1.2 and 2.1.3 of this ETA.

2.6. Maintenance, replacement and repair

MAGOXX® Board shall be maintained, replaced and/or repaired in accordance to the manufacturer's technical documentation.

2.7. Auxiliary components

Described (auxiliary) components as used in the tested constructions have not been assessed.

3. Performance of the product and references to the methods used for its assessment

3.1. BWR 2 – Safety in case of fire

3.1.1. Reaction to fire

MAGOXX® Board, in relation to its reaction of fire behaviour is tested in accordance with EN ISO 1182 and EN ISO 1716 and classified according to EN 13501-1.

Product characteristic	Performance per thickness (mm)					
	4	6	9	12	15	18
Reaction to fire	Class A1					

3.1.2. Resistance to fire

3.1.2.1. Timber floor construction, product family type 1

The resistance to fire of a horizontal membrane with ≥ 9 mm MAGOXX® Board protection is tested in accordance with EN 1365-2 and classified according to EN 13501-2:2016.

Description	Performance
Timber floor construction with an additional uniformly distributed load of 150 kg/m ² , protected with MAGOXX® Board.	REI 60, RE 60
<p>Composition of construction, top to bottom:</p> <ul style="list-style-type: none"> - Prefabricated flooring elements consisting of 18+6 mm MAGOXX® Board (1200 x 600 mm) with a 50 mm overlap. At the overlap, the flooring elements are screwed together with 3,4 x 25 mm drywall screws, centre to centre distance 150 mm. - 10 mm coconut felt, type Nevidek. - 18 x 110 x 3000 Spruce floorboards, nailed at each beam with 2 2,7 x 55 mm Arbed nails - Pine beams 75 x 200 mm, 600 mm centre to centre distance. - Between the pine beams 50 mm rock wool, 45 kg/m³. - 9 x 150 mm MAGOXX® Board at each beam, mounted with Ivana 3,5 x 45 mm drywall screws, centre to centre distance 200 mm. - 9 mm MAGOXX® Board (1200 x 2700 mm), mounted with Ivana 3,5 x 45 mm drywall screws, centre to centre distance 200 mm. <p>See Annex 1 for the overview of products and details.</p> <p><i>Remarks:</i></p> <p><i>Test results are directly applicable to a similar untested floor or roof construction providing the following is true:</i></p> <ol style="list-style-type: none"> 1. <i>Changes in measurements of the floor construction and applying additional loads is allowed, only in case the calculated moments and shear forces in the cross section of the supporting structure at maximum are equal to the calculated moments and shear forces of the tested construction and only in case these forces are determined equal to the tested construction. The span of the floor construction may - if possible - be enlarged or reduced. Furthermore the cross-section and measurements of the load-bearing parts may be increased but not decreased.</i> 2. <i>The measurement transverse to the direction of span may be unlimited enlarged or reduced only in case the centre-to-centre distance of the load-bearing parts is not greater than tested (600 mm).</i> 3. <i>The maximum allowed ceiling panels are l*b = 2750*1250, provided the number of mounting points per m² are at least equal as tested.</i> 4. <i>The cavity between the floor- and ceiling panels shall be at least 195 mm but may be increased. T is not allowed to add materials to the cavity, other than tested.</i> 	

3.1.2.2. **Non load-bearing partition with timber frame, product family type 2**

The resistance to fire of 9 mm MAGOXX® Board is tested as a fire separating assembly with no load-bearing requirements. Resistance to fire is tested in accordance with EN 1364-1:2015 and classified according to EN 13501-2:2007+A1:2009.

Description	Performance
Non-loadbearing wall partition with wooden studs, up to 3 m	EI 60, EW 90, E 90
<p>Composition of the symmetrical construction:</p> <ul style="list-style-type: none">- Timber frame of horizontal pinewood profiles (38x70 mm) at top and bottom and vertical pinewood studs (38x70 mm), centre to centre ≤ 600 mm. The horizontal profiles are fastened to the building structure with 6 x 60 mm nail plugs, centre to centre 400-500 mm and the vertical studs with 6 x 60 mm nail plugs, centre to centre ≤ 1000 mm, with a minimum of three plugs.- Between the pine beams 70 mm rock wool, 29 kg/m³.- Both sides of the timber frame are covered with 6 x 150 mm wide strip MAGOXX® Board fastened individually to timber profiles with 3,5 x 35 mm drywall screws, centre to centre ≤ 250 mm. On top, 9 mm MAGOXX® Board is fastened with 3,5 x 50 mm drywall screws, centre to centre ≤ 250 mm.- The joints between the 9 mm (or 12 mm) MAGOXX® Boards are blunt and just like the drywall screws unfinished.- Between ceiling, floor and walls 2 x 30 mm sealing tape and elastic fire resistant silicone adhesive shall be used. <p>See Annex 2 for the overview of products and details.</p>	
<p>Remarks:</p> <ol style="list-style-type: none">1. <i>The construction may be applied up to a height of 4 m, provided that the expansion possibilities are increased proportionally.</i>2. <i>Results are directly applicable to similar constructions where one or more of the changes listed below are made and the construction continuous to comply with the appropriate design code for its stiffness and stability:</i><ul style="list-style-type: none">- decrease in height;- decrease in dimensions length and width of the boards, but not thickness;- decrease in stud spacing;- decrease in distance of fixing centres;- Increase in thickness of the wall, component materials;- increase in the number of horizontal and vertical joints, of the type tested.	

3.1.2.3. **Non load-bearing partition with metal frame, product family type 2**

The resistance to fire of 9 mm MAGOXX® Board is tested as a fire separating assembly with no load-bearing requirements. Resistance to fire is tested in accordance with EN 1364-1:2015 and classified according to EN 13501-2:2017+A1:2009.

Description	Performance
Non-loadbearing wall partition with metal frame, up to 3 m	EI 60, EW 60, E 60
Non-loadbearing wall partition with metal frame, up to 4 m	EI 30, EW 30, E 30
<p>Composition of the symmetrical construction:</p> <ul style="list-style-type: none">- Metal frame consisting of C (vertical) and U (horizontal) profiles 50 x 70 mm. The profiles are fastened to the building structure with 6 x 60 mm nail plugs, centre to centre 400-500 mm at the top and bottom and along the sides centre to centre ≤ 1000 mm, with a minimum of three plugs.- Between the metal profiles 70 mm rock wool, 29 kg/m³.- Both sides of the metal frame are covered with 6 x 150 mm wide strip MAGOXX® Board fastened individually to the metal profiles with 3,5 x 35 mm drywall screws, centre to centre ≤ 250 mm. On top, 9 mm MAGOXX® Board is fastened with 3,5 x 45 mm drywall screws, centre to centre ≤ 250 mm.- The joints between the 9 mm (or 12 mm) MAGOXX® Boards are blunt and just like the drywall screws unfinished.- Between ceiling, floor and walls 2 x 30 mm sealing tape and elastic fire resistant silicone adhesive shall be used. <p>See Annex 3 for the overview of products and details.</p>	
<p>Remarks:</p> <ol style="list-style-type: none">1. <i>The construction may be applied up to a height of 4 m, provided that the expansion possibilities are increased proportionally and considering change in performance as mentioned in this table.</i>2. <i>Results are directly applicable to similar constructions where one or more of the changes listed below are made and the construction continuous to comply with the appropriate design code for its stiffness and stability:</i><ul style="list-style-type: none">- decrease in height;- decrease in dimensions length and width of the boards, but not thickness;- decrease in stud spacing;- decrease in distance of fixing centres;- Increase in thickness of the wall and/or component materials;- increase in the number of horizontal and vertical joints, of the type tested.	

3.1.2.4. Non load-bearing partition with metal frame, product family type 2

The resistance to fire of 12 mm MAGOXX® Board is tested as a fire separating assembly with no load-bearing requirements. Resistance to fire is tested in accordance with EN 1364-1:2015 and classified according to EN 13501-2:2017+A1:2009.

Description	Performance																						
Non-loadbearing wall partition with metal frame, up to 3 m	EI 45, EW 120, E 120																						
Non-loadbearing wall partition with metal frame, up to 4 m	EI 30, EW 30, E 30																						
<p>Composition of the symmetrical construction:</p> <ul style="list-style-type: none"> - Metal frame consisting of top and bottom metal UW-75 profiles (75 x 40 x 0.6 mm) and vertical CW-75 profiles (75 x 50 x 0.6 mm). The profiles are fastened to the building structure with 6 x 55 mm nail plugs, centre to centre 600 mm. The center to center distance between the CW-75 vertical profiles is 600 mm. - Between the metal profiles 70 mm rock wool, 36 kg/m³, fitted tightly clamped between the CW profiles. - Both sides of the metal frame are covered with 12 mm MAGOXX® Board fastened with 3,9 x 30 mm drywall screws, center to center 200 mm. The screws are not finished. - The joints between the 12 mm MAGOXX® Boards are blunt (butt joint ≤ 1 mm) and are finished with a joint filler, type Fix and Finish. - Between ceiling, floor and walls 2 x 30 mm sealing tape and elastic fire resistant silicone adhesive shall be used. <p>See Annex 4 for the overview of products and details.</p>																							
<p>Extended applications (EXAP):</p> <ul style="list-style-type: none"> - Lining: <ul style="list-style-type: none"> - Exchange of type of boards is not allowed. - An increase of the number of layers of MAGOXX® Board is permitted for EI 45, EW 120, E 120, on the condition that the length of the fixings are increased in function of the total thickness of the lining. Added layers shall be at least the density of the tested board. - Decrease of distance of fixing centers is permitted, increase of distance is not. - Thickness of boards with increase of layers: <table border="1"> <thead> <tr> <th>Classification period [min]</th> <th>Max. decrease thickness per board [%]</th> <th>Min. allowable thickness per board [mm]</th> <th>Min. increase thickness total lining [%]</th> <th>Min. total thickness total lining [mm]</th> </tr> </thead> <tbody> <tr> <td>EI 45</td> <td rowspan="2">25</td> <td rowspan="2">9</td> <td rowspan="2">10</td> <td rowspan="2">15</td> </tr> <tr> <td>EW 90, E 90</td> </tr> </tbody> </table> - Dimensions of boards: <table border="1"> <thead> <tr> <th>Classification period [min]</th> <th>Max. allowable length [%]</th> <th>Max. allowable length [mm]</th> <th>Max. allowable width [%]</th> <th>Max. allowable width [mm]</th> </tr> </thead> <tbody> <tr> <td>EI 45</td> <td rowspan="2">25</td> <td rowspan="2">3750</td> <td rowspan="2">5</td> <td rowspan="2">1260</td> </tr> <tr> <td>EW 90, E 90</td> </tr> </tbody> </table> <p>Note: With changing the dimensions, the centre to centre distances of vertical studs shall be adapted accordingly.</p> <ul style="list-style-type: none"> - Boards may only be applied in vertical orientation ('portrait') for EI 45, EW 120 and E 120. - Metal framework (as determined i.a.w. EN 14195): <ul style="list-style-type: none"> - A change of shape of the metal profiles is not permitted. - The nominal wall thicknesses of the steel profiles can be increased without limitations for EI 45, EW 120 and E 120. A decrease is not permitted. 		Classification period [min]	Max. decrease thickness per board [%]	Min. allowable thickness per board [mm]	Min. increase thickness total lining [%]	Min. total thickness total lining [mm]	EI 45	25	9	10	15	EW 90, E 90	Classification period [min]	Max. allowable length [%]	Max. allowable length [mm]	Max. allowable width [%]	Max. allowable width [mm]	EI 45	25	3750	5	1260	EW 90, E 90
Classification period [min]	Max. decrease thickness per board [%]	Min. allowable thickness per board [mm]	Min. increase thickness total lining [%]	Min. total thickness total lining [mm]																			
EI 45	25	9	10	15																			
EW 90, E 90																							
Classification period [min]	Max. allowable length [%]	Max. allowable length [mm]	Max. allowable width [%]	Max. allowable width [mm]																			
EI 45	25	3750	5	1260																			
EW 90, E 90																							

- Depth of the metal profiles:

Classification period [min]	Max. decrease of depth [%]	Min. allowable depth [mm]
EI 45	10	67,5
EW 90, E 90		

- The nominal dept of the steel profiles can be increased without any limitations EI 45, EW 120 and E 120, on the condition that the shape of the steel profiles has not changed. The thickness of the insulation must be increased pro rata.
- The nominal width of the steel profiles onto which the lining is fixed, can be increased without limitations for EI 45, EW 120 and E 120, on the condition that the shape of the profiles is not changed. A decrease is not permitted.
- Stud spacing:
An increase of the stud spacing is permitted as per table below, on the condition that the vertical joints are located at the studs.

Classification period [min]	Max. allowable increase c.t.c. [%]	Max. allowable increase c.t.c. [mm]
EI 45	5	630
EW 90, E 90		

- A decrease of stud spacing is always permitted for EI 45, EW 120 and E 120, on the condition that the vertical joints are located at the studs.
- Insulation
 - EXAP rules below are only valid for mineral wool as defined in EN 13162.
 - Removal of the rock wool is not permitted.
 - Exchange of rock wool by glass wool is not permitted.
 - An increase of the density of the rock wool is permitted for EI 45, EW 120, E 120.
 - A decrease the density of the rock wool is permitted according to the table below.

Classification period [min]	Max. allowable decrease [%]	Min. allowable density [kg/m ²]
EI 45	10	25
EW 90, E 90		

- An increase of the thickness of the rock wool is permitted for EI 45, EW 120, E 120.
- A decrease the thickness of the rock wool is permitted according to the table below.

Classification period [min]	Max. allowable decrease [%]	Min. allowable thickness [mm]
EI 45	10	63
EW 90, E 90		

- Height and width of the partition
The height of the partition can be increased according to the table below.

Classification period [min]	Increase of height tested partition ≤ 1 m	Increase of height tested partition ≤ 2 m	Increase of height tested partition ≤ 3 m
EI 30, EW 30, E30	Increments pro rata	Not possible	Not possible
EI 20, EW 20, E 20	Increments pro rata	Increments pro rata	Increase thickness of the lining at both sides ≥ 6 mm by adding extra layer or increasing thickness of the boards AND Increments pro rata

- The extended application rules regarding the height are applicable to the tested lining, the insulation and metal framework of the partition. In any case the extended height shall be lower than the maximum allowed height in ambient conditions as declared by the manufacturer.

- Increase of width is permitted for EI 45, EW 120 and E 120.

3.1.2.5. Non load-bearing partition with metal frame, product family type 2

The resistance to fire of 2x 6 mm MAGOXX® Board is tested as a fire separating assembly with no load-bearing requirements. Resistance to fire is tested in accordance with EN 1364-1:2015 and classified according to EN 13501-2:2017+A1:2009.

Description	Performance
Non-loadbearing wall partition with metal frame, up to 3 m	EI 45, EW 120, E 120
Non-loadbearing wall partition with metal frame, up to 4 m	EI 30, EW 30, E 30
<p>Composition of the symmetrical construction:</p> <ul style="list-style-type: none"> - Metal frame consisting of top and bottom metal UW-75 profiles (75 x 40 x 0.6 mm) and vertical CW-75 profiles (75 x 50 x 0.6 mm). The profiles are fastened to the building structure with 6 x 55 mm nail plugs, centre to centre 600 mm. The center to center distance between the CW-75 vertical profiles is 600 mm. - Between the metal profiles 70 mm rock wool, 41 kg/m³, fitted tightly clamped between the CW profiles. - Both sides of the metal frame are covered with a double layer of 2x 6 mm MAGOXX® Board fastened with 3,9 x 30 mm drywall screws, center to center 200 mm. The screws are not finished. - The first layer has a horizontal blunt joint (butt joint ≤ 1 mm) which is unfinished. - The second, top layer has a horizontal blunt (butt joint ≤ 1 mm) joint which is finished with a joint filler, type Fix and Finish. - Between ceiling, floor and walls 2 x 30 mm sealing tape and elastic fire resistant silicone adhesive shall be used. <p>See Annex 5 for the overview of products and details.</p>	
<p>Extended applications (EXAP):</p> <ul style="list-style-type: none"> - Lining: <ul style="list-style-type: none"> - Exchange of type of boards is not allowed. - An increase of the number of layers of MAGOXX® Board is permitted for EI 45, EW 120, E 120, on the condition that the length of the fixings are increased in function of the total thickness of the lining. Added layers shall be at least the density of the tested board. 	

- Decrease of distance of fixing centers is permitted, increase of distance is not.
- Thickness of boards with increase of layers:

Classification period [min]	Max. decrease thickness per board [%]	Min. allowable thickness per board [mm]	Min. increase thickness total lining [%]	Min. total thickness total lining [mm]
EI 45	25	4,5	10	15
EW 120, E 120				

- Dimensions of boards:

Classification period [min]	Max. allowable length [%]	Max. allowable length [mm]	Max. allowable width [%]	Max. allowable width [mm]
EI 45	25	3312,5	5	1260
EW 120, E 120				

Note: With changing the dimensions, the centre to centre distances of vertical studs shall be adapted accordingly.

- Boards may only be applied in vertical orientation ('portrait') for EI 45, EW 120 and E 120.
- Metal framework (where applicable as determined i.a.w. EN 14195):
 - A change of shape of the metal profiles is not permitted.
 - The nominal wall thicknesses of the steel profiles can be increased without limitations for EI 45, EW 120 and E 120. A decrease is not permitted.
 - Depth of the metal profiles:

Classification period [min]	Max. decrease of depth [%]	Min. allowable depth [mm]
EI 45	10	67,5
EW 120, E 120		

- The nominal dept of the steel profiles can be increased without any limitations EI 45, EW 120 and E 120, on the condition that the shape of the steel profiles has not changed. The thickness of the insulation must be increased pro rata.
- The nominal width of the steel profiles, onto which the lining is fixed, can be increased without limitations for EI 45, EW 120 and E 120, on the condition that the shape of the profiles is not changed. A decrease is not permitted.
- Stud spacing:
An increase of the stud spacing is permitted as per table below, on the condition that the vertical joints are located at the studs.

Classification period [min]	Max. allowable increase c.t.c. [%]	Max. allowable increase c.t.c. [mm]
EI 45	5	630
EW 120, E 120		

- A decrease of stud spacing is always permitted for EI 45, EW 120 and E 120, on the condition that the vertical joints are located at the studs.
- Insulation
 - EXAP rules below are only valid for mineral wool as defined in EN 13162.
 - Removal of the rock wool is not permitted.
 - Exchange of rock wool by glass wool is not permitted.
 - An increase of the density of the rock wool is permitted for EI 45, EW 120, E 120.

- A decrease the density of the rock wool is permitted according to the table below.

Classification period [min]	Max. allowable decrease [%]	Min. allowable density [kg/m ²]
EI 45	10	31,5
EW 120, E 120		

- An increase of the thickness of the rock wool is permitted for EI 45, EW 120, E 120.
- A decrease the thickness of the rock wool is permitted according to the table below.

Classification period [min]	Max. allowable decrease [%]	Min. allowable thickness [mm]
EI 45	10	63
EW 120, E 120		

- Height and width of the partition

The height of the partition can be increased according to the table below.

Classification period [min]	Increase of height tested partition ≤ 1 m	Increase of height tested partition ≤ 2 m	Increase of height tested partition ≤ 3 m
EI 30, EW 30, E 30	Increments pro rata	Increments pro rata	Increase thickness of the lining at both sides ≥ 6 mm by adding extra layer or increasing thickness of the boards (2x 9 mm) AND Increments pro rata

- The extended application rules regarding the height are applicable to the tested lining, the insulation and metal framework of the partition. In any case the extended height shall be lower than the maximum allowed height in ambient conditions as declared by the manufacturer.
- increase of width is permitted for EI 45, EW 120 and E 120.

3.1.3. Durability and serviceability

3.1.3.1. Working life

Expected economically reasonable working life of MAGOXX® Board:

- < 9 mm board: 25 years when applied during/in conditions according to use category type Z2: internal use where more than accidental wetting or frost is not to be expected.
- ≥ 9 mm board: 25 years when applied during/in conditions according to use category type X: all uses (internal, semi-exposed and exposed use).

3.1.3.2. Intended climatic conditions

Intended climatic conditions for MAGOXX® Board is determined on basis basic and extended durability assessment.

Use type	Climatic conditions	Suitability per thickness (mm)					
		4	6	9	12	15	18
Type X	Internal, semi-exposed and exposed use	N	N	Y	Y	Y	Y
Type Y	Internal and semi-exposed use	N	N	Y	Y	Y	Y

Type Z ₁	Internal use in high humidity environments but where more than accidental wetting and/or frost is not to be expected	N	N	Y	Y	Y	Y
Type Z ₂	Internal use only	Y	Y	Y	Y	Y	Y

Explanations:

N : Not suited for this climatic condition

Y : Suited for this climatic condition

3.1.3.3. Adhesion of finishings

NPA: adhesion of finishings is not assessed.

3.2. BWR 3 – Hygiene, health and environment

Water permeability is tested in accordance with EN 12467, clause 7.3.3 and assessed with based on the requirement: traces of moisture may appear under surface of the sheet but there shall be no formation of drops of water.

Characteristic	Unit	Performance per thickness (mm)					
		4	6	9	12	15	18
Water permeability	--	NPA	NPA	No water drops			

3.3. BWR 4 – Safety in use

3.3.1. Flexural strength

Flexural strength is tested in accordance with EN 12467, clause 7.3.2.

Characteristic	Unit	Performance per thickness (mm)					
		4	6	9	12	15	18
Flexural strength							
Modulus of rupture (MOR)	MPa	27,48	19,81	10,69	20,70	12,30	8,02
Modulus of rupture, conditioned ^[5]	MPa	26,27	17,34	11,23	20,90	NPA	7,11

^[5] After conditioning in accordance to category A, EN 12467

3.3.2. Dimensional stability

Dimensional stability is tested in accordance with EN 318.

Characteristic	Unit	Performance per thickness (mm)						
		4	6	9	12	15	18	
Dimensional stability	mm							
Change in length (mm/m)	$\delta_{65, 85}$	mm/m	NPA	NPA	$\leq 0,4$	$\leq 0,6$	NPA	NPA
	$\delta_{65, 30}$	mm/m	NPA	NPA	$\leq -1,0$	$\leq -2,1$	NPA	NPA
Change in thickness (%)	$\delta_{65, 85}$	%	NPA	NPA	$\leq -0,2$	$\leq 0,2$	NPA	NPA
	$\delta_{65, 30}$	%	NPA	NPA	$\leq 0,2$	$\leq -0,3$	NPA	NPA

3.4. BWR 6 – Energy economy and heat retention

3.4.1. Thermal resistance

The thermal conductivity (λ) is determined in accordance with EN 12667.

Characteristic	Unit	Performance per thickness (mm)					
		4	6	9	12	15	18
Thermal conductivity (λ)	W/(m·K)	NPA	NPA	$\leq 0,234$	$\leq 0,231$	NPA	NPA

3.4.2. Water vapour transmission coefficient

The water vapour transmission coefficient is determined in accordance with EN ISO 12572.

Characteristic	Unit	Performance per thickness (mm)					
	mm	4	6	9	12	15	18
Water vapour resistance factor	μ_{mean}	NPA	NPA	61,9	45,2	NPA	NPA

4. Assessment and verification of constancy of performance (hereinafter AVCP) system applied, with reference to its legal base

According to the decision 1999/454/EC, published in the Official Journal of the European Union (OJEU) L178 of 14/07/1999) of the European Commission, the systems of assessment and verification of constancy of performance (see Annex V to Regulation (EU) No 305/2011) given in the following table apply:

Product	Intended use	Levels or classes	Systems
Fire protective products	For fire compartmentation and/or fire protection or fire performance	Any	1

4.1. Tasks for the manufacturer

4.1.1. Factory production control

The manufacturer shall exercise permanent internal control of production. All the elements, requirements and provisions adopted by the manufacturer shall be documented in a systematic manner in the form of written policies and procedures, including records of results performed. This production control system shall insure that the product is in conformity with this European Technical Approval.

Within the framework of FPC the manufacturer shall carry out tests and controls with the prescribed test plan as deposited at Kiwa Nederland B.V., which is part of this European Technical Approval.

The results of the FPC shall be recorded and shall be kept for a period of at least 10 years. The results of the FPC are evaluated and shall include at least the following information:

- designation of products and the constituents (raw materials);
- method of control or testing;
- date of manufacture of the products and date of testing of the products and the constituents;
- result of control and testing and comparison with requirements and declarations;
- result of treatment of products which do not meet declarations;
- signature of the person responsible for the FPC.

On request the results shall be presented to Kiwa Nederland B.V.

The test plan shall contain in detail the extent, nature and frequency of testing and controls to be performed and shall address at least the following items/characteristics and (minimum) frequencies as detailed in table 2.

Table 4.1.1-1 - Control plan for the manufacturer; cornerstones

No	Subject/type of control	Test or control method	Criteria	Minimum frequency of control
Factory Production Control (FPC)				
1	Quality management (system)	According to clause 3.4 of EAD 350142-00-1106		
2	Incoming material	DoP or tests according to quality manual	Manufacturers's declaration	Every delivery
3	Testing during production		Manufacturers's declaration	According to quality manual

Factory Production Control (FPC): testing of the final boards				
4	Determination of organic content (reaction to fire)	EN 13820	Manufacturers declaration	1 per week
5	Determination of dimensional stability at high temperatures (fire resistance)	EN 1094-6 (sample size 100 x 100 mm)		1 per week
6	Indirect test method ^[6]	t.b.d.		As appropriate
7	Water permeability	EN 12467, 7.3.3		1 per 3 years
8	Dimensional stability	EN 318		1 per year
9	Thermal resistance	EN 12667 / EN 12939 / EN 993-14 / EN ISO 13787		1 per 2 years
10	Water vapour transmission coefficient	EN ISO 12572		1 per 2 years
Technical characterisation				
11	Length and width	EN 12467, 5.3.2	Manufacturers declaration	1 per day ^[7] , per dimension
12	Thickness	EN 12467, 5.3.3		1 per day, per thickness
13	Apparent density	EN 12467, 5.3.4		1 sample per n boards
14	Shape:			1 sample per n boards
14a	Straightness of edges	EN 12467, 5.3.5.1	Inspection S3 s in ISO 390, 4% AQL	1 sample per n boards
14b	Squareness of edges	EN 12467, 5.3.5.2		
15	Flexural strength	EN 12467, 7.3.2	Inspection S3 s in ISO 390, 4% AQL	1 sample per n boards

^[6] Production shall be subjected to (at least) one additional FPC test that is related to fire resistance characteristics and that is especially relevant for the product under construction. The manufacturer and the Assessment Body shall determine an appropriate frequency.

^[7] A day represents a 24 hour time period in which production is considered to be 'normal'.

4.1.2. Declaration of performance

The manufacturer shall draw up a Declaration of Performance stating that MAGOXX® Board is in conformity with the provisions of this European Technical Approval.

4.2. Tasks for the approved body

The approved body shall perform the initial type testing of the product.

5. Technical details necessary for the implementation of the AVCP system, as provided for in the applicable EAD

The manufacturing process of the products is in accordance with the process that is agreed between SINH Building Solutions B.V. and Kiwa.

Changes to the product/production process, which could result in this deposited data / information being incorrect, should be notified to the approval body before the changes are introduced. The approval body will decide whether or not such changes affect the ETA and consequently the validity of the CE marking on the basis of the ETA and so whether further assessment / alterations to the ETA, is necessary.

Issued in Rijswijk on (05-09-2021) by

A handwritten signature in black ink, appearing to read 'Ron Scheepers', with a long horizontal stroke extending to the right.

Ron Scheepers
Kiwa Nederland B.V.

Annex 1

Components timber floor construction

Component	Specification
MAGOXX® Board flooring elements	18+6 mm, 915 kg/m ³
MAGOXX® Board	9 mm, 1000 kg/m ³
Flooring elements	Spruce, 18 x 110 mm, 396 kg/m ³
Wooden beams	Pinewood, 75 x 200 mm, 494 kg/m ³
Insulation	Rockwool 210, 50 mm rockwool, 45 kg/m ³
Coconut felt	Nevidek 10 mm, 150 mm, 150 kg/m ³
Gypsum board screws	Ivana 3,4 x 25 mm and 3,5 x 45 mm
Nails	Arbed 2,7 x 55 mm

Drawings / details timber floor construction

Detail A

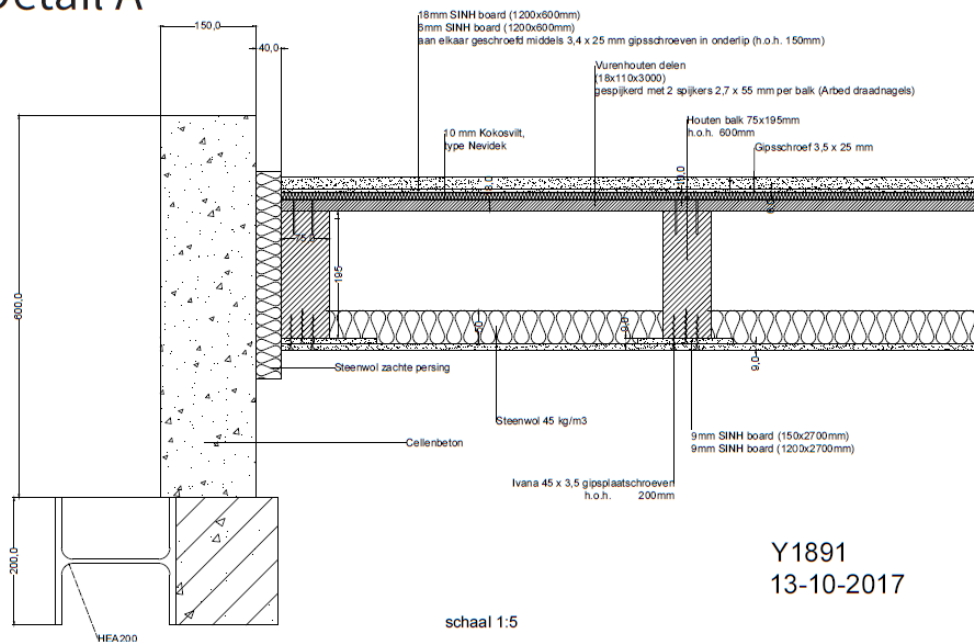

Detail B

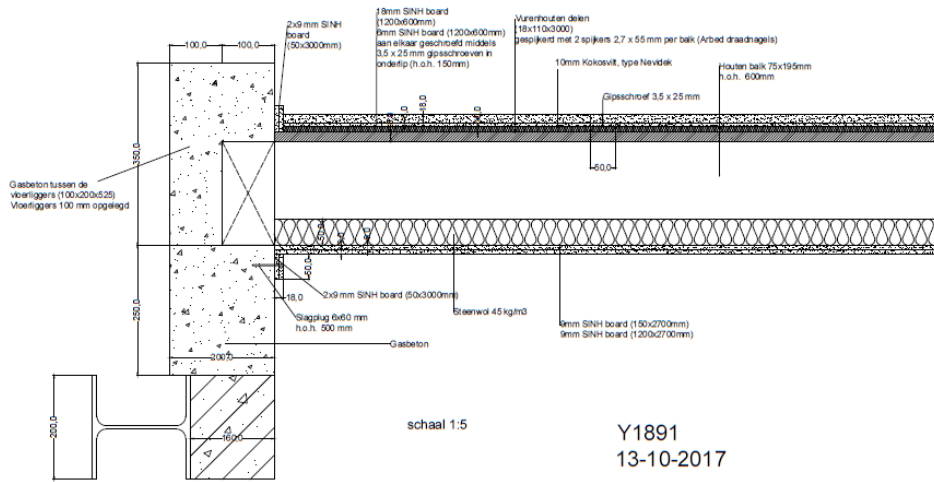

Annex 2

Components Non load-bearing partition with timber frame

Component	Specification
MAGOXX® Board	6 mm, 1043 kg/m ³
MAGOXX® Board	9 mm, 1009 kg/m ³
Wooden studs	Pinewood, 38 x70 mm, 581 kg/m ³
Drywall screws	3,5 x 35 mm and 3,5 x55 mm
Insulation	Rockwool 210, 70 mm rock wool, 29 kg/m ³
Nail plugs	6 x 60 mm
Knauf sealing tape	2 x 30 mm wide
Elastic fire resistant silicone adhesive	Nulifire FS 703

Drawings / details Non load-bearing partition with wooden studs

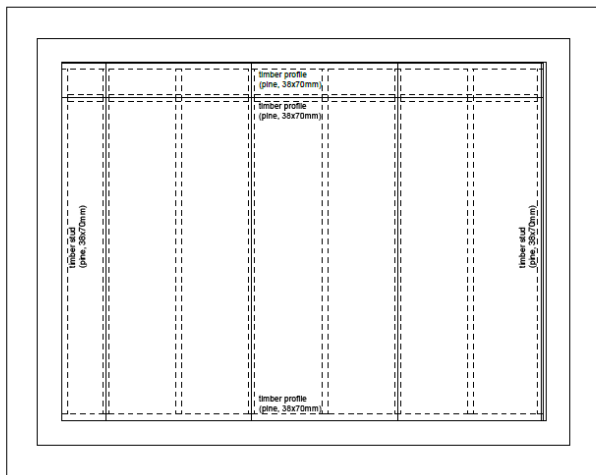

ELEVATION

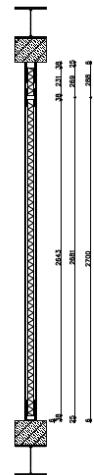

VERTICAL SECTION

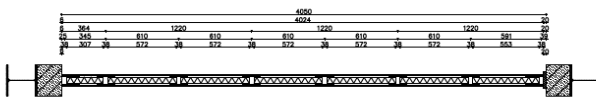

HORIZONTAL SECTION

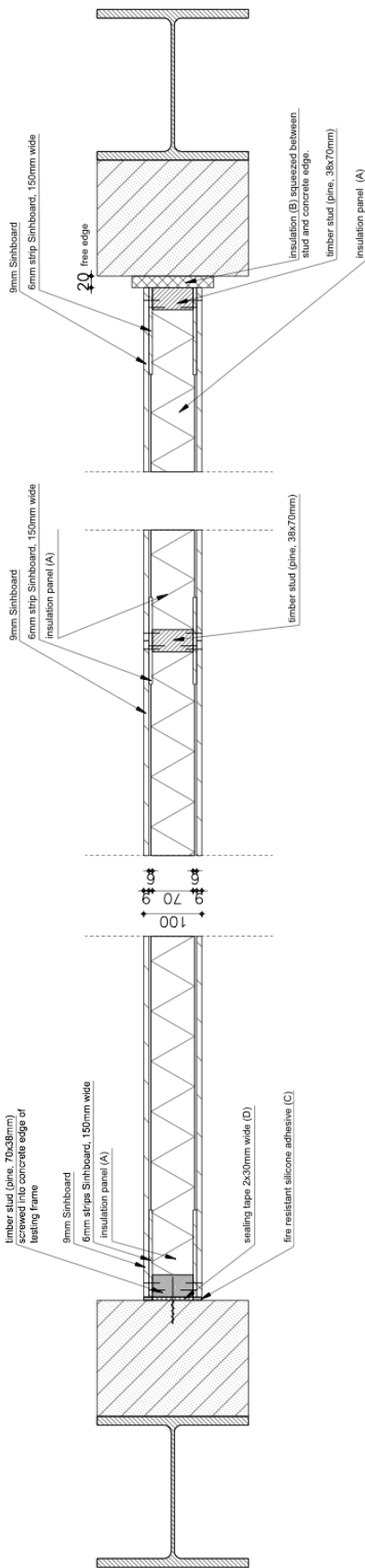

HORIZONTAL SECTION

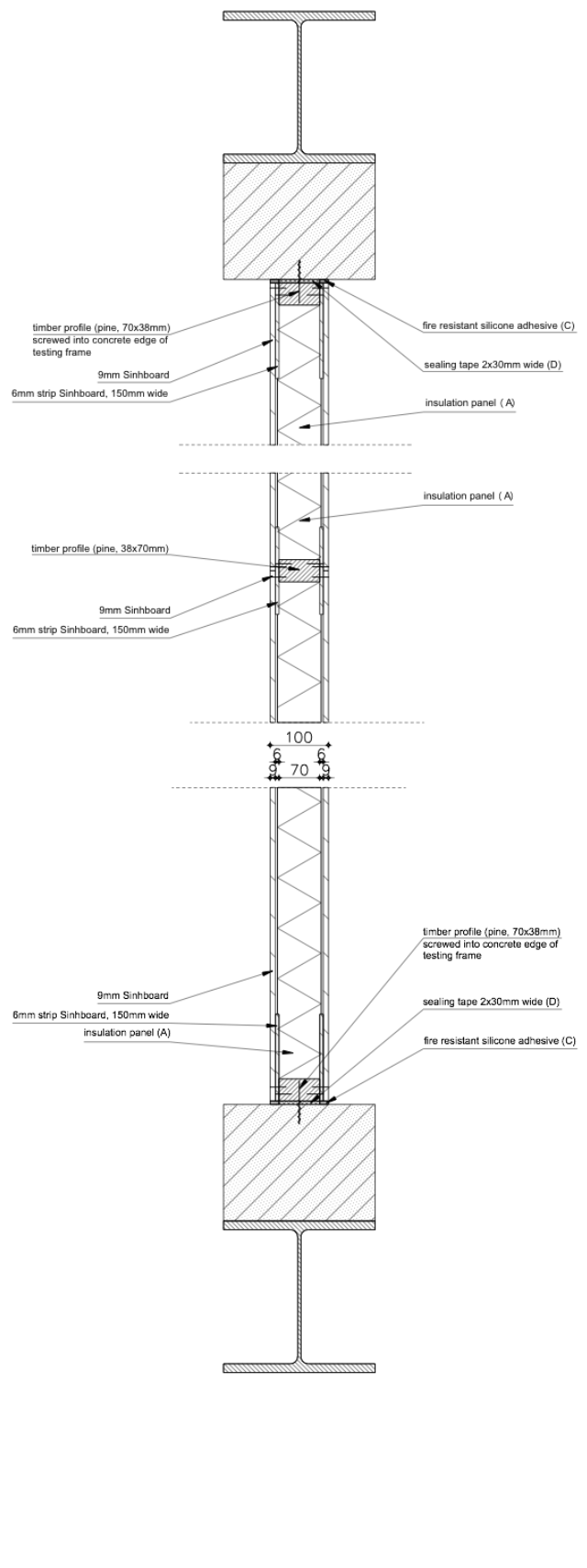

VERTICAL SECTION

Annex 3

Components Non load-bearing partition with metal frame

Component	Specification
MAGOXX® Board	6 mm, 1039 kg/m ³
MAGOXX® Board	9 mm, 1004 kg/m ³
Metal C and U profiles	50 x 70 mm
Drywall screws	3,5 x 35 mm and 3,5 x55 mm
Insulation	Rockwool 210, 70 mm rock wool, 29 kg/m ³
Nail plugs	6 x 60 mm
Knauf sealing tape	50 mm wide
Elastic fire resistant silicone adhesive	Nulifire FS 703

Drawings / details Non load-bearing partition with metal studs

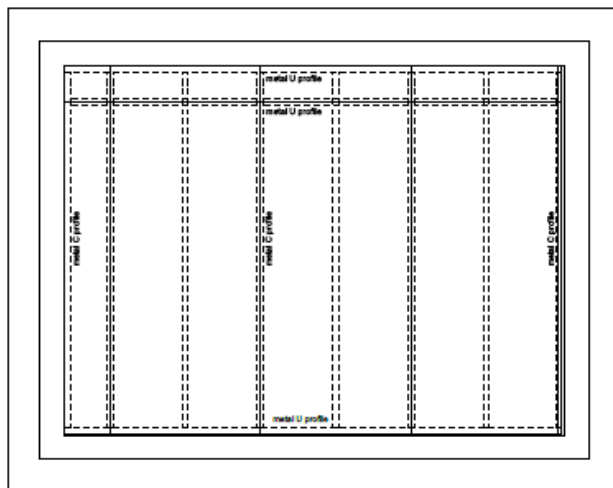

ELEVATION



VERTICAL SECTION

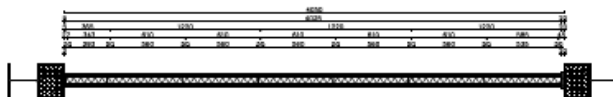

HORIZONTAL SECTION

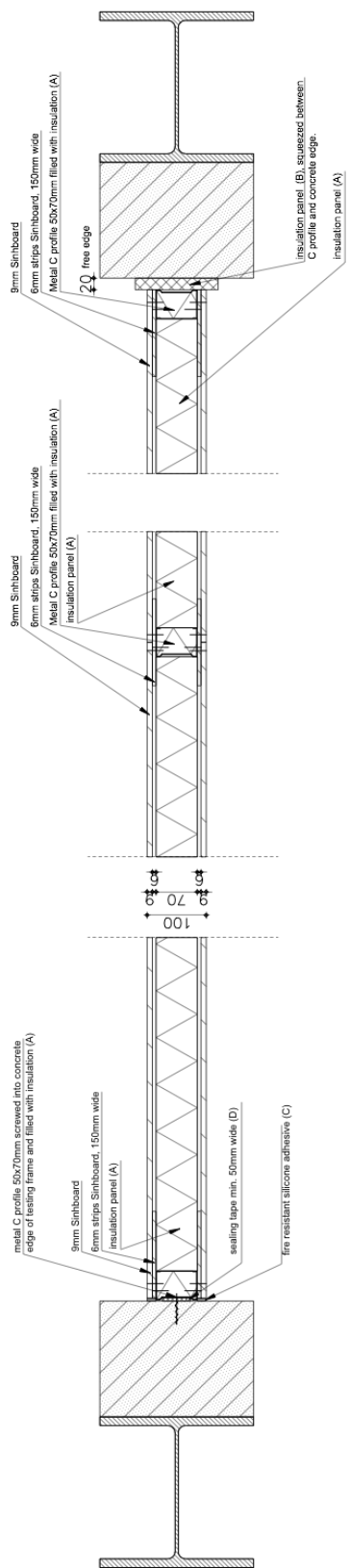

HORIZONTAL SECTION

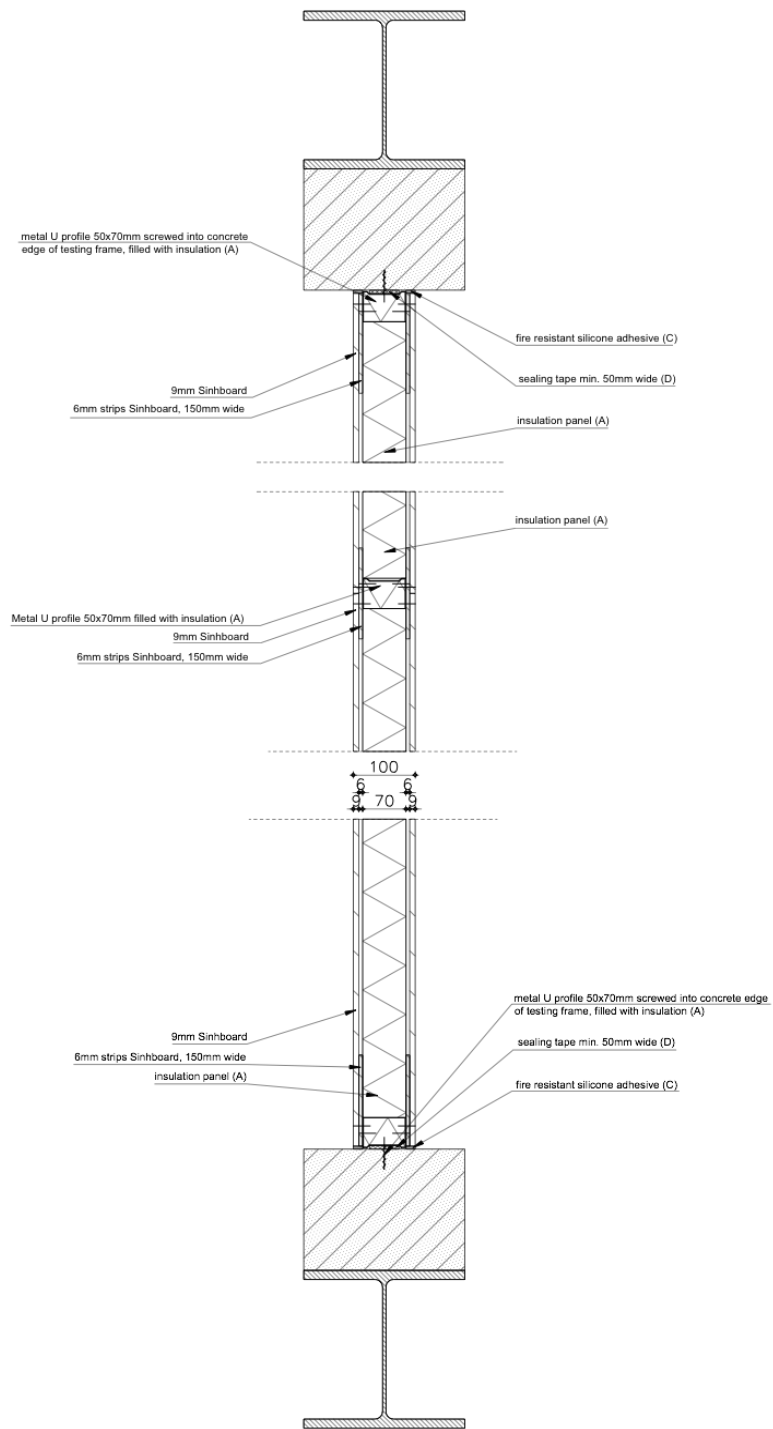

VERTICAL SECTION

Annex 4

Components Non load-bearing partition with metal frame, 1x 12 mm MAGOXX® Board

Component	Specification
MAGOXX® Board	12 mm, 1004 kg/m ³
Metal C profiles	40 x 75 x 0.6 mm
Metal U profiles	50 x 75 x 0.6 mm
Drywall screws	3,9 x 30 mm and 3,5 x 55 mm
Insulation	Rockwool 210, 70 mm rock wool, 36 kg/m ³
Nail plugs	6 x 60 mm
Knauf sealing tape	50 mm wide
Elastic fire resistant silicone adhesive	Nullfire FS 703

Drawings / details Non load-bearing partition with metal studs

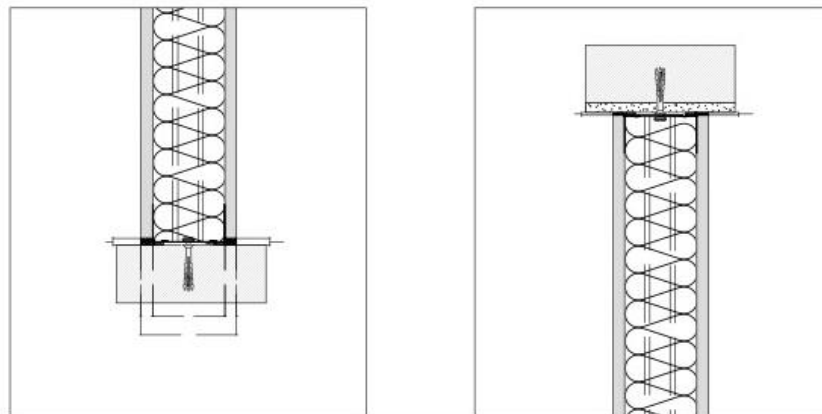

VERTICAL SECTIONS

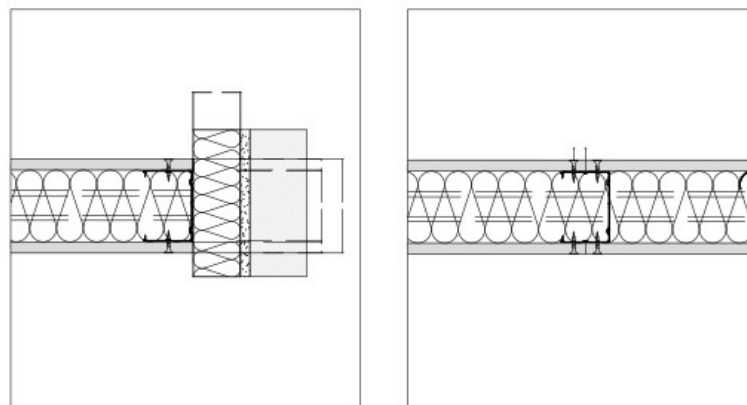

HORIZONTAL SECTIONS

Annex 5

Components Non load-bearing partition with metal frame, 2x 6 mm mm MAGOXX® Board

Component	Specification
MAGOXX® Board	6 mm, 1039 kg/m ³
Metal C profiles	40 x 75 x 0.6 mm
Metal U profiles	50 x 75 x 0.6 mm
Drywall screws	3,9 x 30 mm
Insulation	Rockwool 210, 70 mm rock wool, 41 kg/m ³
Nail plugs	6 x 60 mm
Knauf sealing tape	50 mm wide
Elastic fire resistant silicone adhesive	Nullfire FS 703

Drawings / details Non load-bearing partition with metal studs

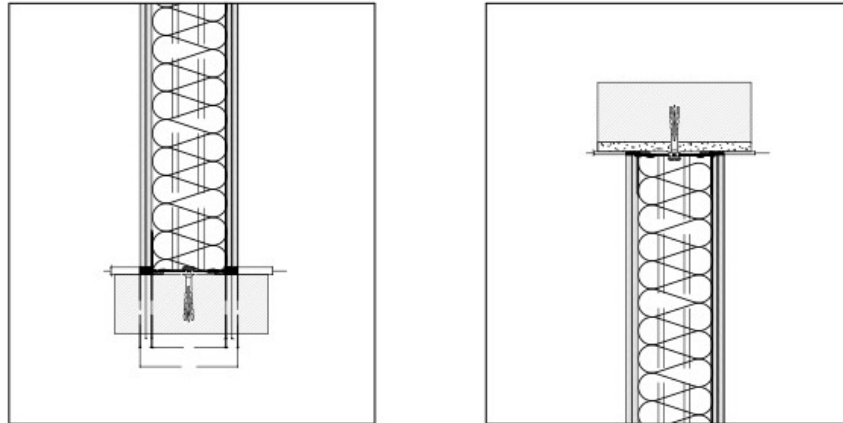

VERTICAL SECTIONS

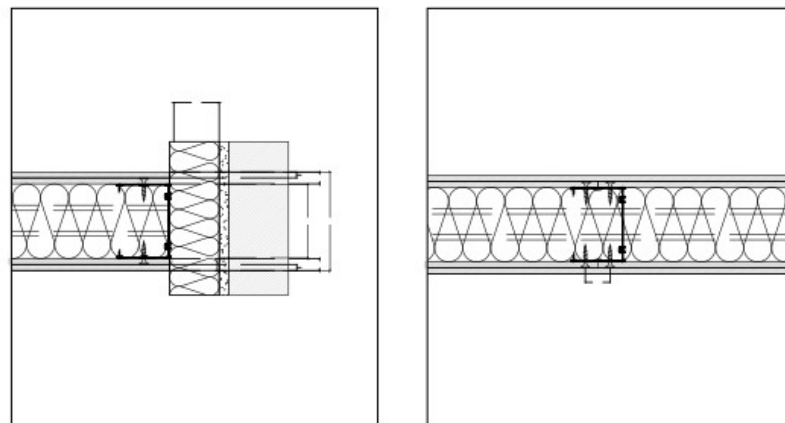

HORIZONTAL SECTIONS

Annex 6

Locations China

Main office:

SINH Ningbo Construction Material Co. Ltd.
Room 12B03, Shangdong Int'l Bldg 1
No. 1926 Canghai Road
315041 Ningbo, China

Production plant 1:

known by KIWA